



Talenti[®]

OUTDOOR LIVING

ACCESSORIES

Talenti®
OUTDOOR LIVING

ACCESSORIES

INDEX

Jackie	05
Zeus	35
Athena	43
Venere	53
Marte	61
Vulcano	71
Apollo	77
Carpet	83
Casilda	97
Tribal	103
Cleo	113
Milo	127
Tofee	135
Scacco	141
Tikal	149
Wave	155
Cart	159
Ray	167
Box	173
Planter	179
Upperalu	189



Jackiecollection





Jackiecollection

small, medium & big pouf
dark grey colour











Jackiecollection

small & big lamp
dove colour









Jackiecollection

planter
white colour



Jackiecollection

Finishing

Aluminium frame



white



graphite

Steel frame



white



graphite

Synthetic ropes



dove



light grey



dark grey



hunter green

Wood slats



teak

BEAN BAG / CODE: JACBAG



Width 117 | Depth 167 | Height 62

KG 30,0 | unit 1 1.08 mc | 9% |

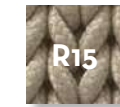

LIVING ARMCHAIR / CODE: JACPL



Width 80 | Depth 78 | Height 73 | H. armrest 57 | H. seat 35

KG 14,0 | unit 2 0.54 mc | 9% |

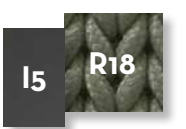
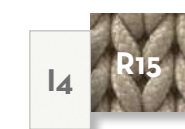

POUF SMALL / CODE: JACPUFP



Width 57 | Depth 57 | Height 26

KG 5,0 | unit 1 0.09 mc | 9% |

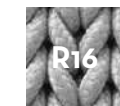
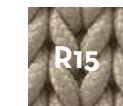

POUF MEDIUM / CODE: JACPUFM



Width 64 | Depth 64 | Height 32

KG 7,0 | unit 1 0.09 mc | 9% |

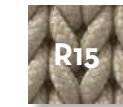

POUF BIG / CODE: JACPUFG



Width 83 | Depth 83 | Height 38

KG 11,0 | unit 1 0.28 mc | 9% |

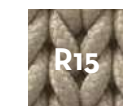

LAMP SMALL / CODE: JACLAMPP

KG 7,0 | unit 1 0,15 mc | LED 5W 2700K



Width 55 | Depth 55 | Height 42



LAMP BIG / CODE: JACLAMPG

KG 11,0 | unit 1 0,33 mc | LED 5W 2700K



Width 70 | Depth 70 | Height 60



FLOOR LAMP / CODE: JACLAMPT

KG 16,0 | unit 1 0,48 mc | LED 5W 2700K



Width 55 | Depth 55 | Height 150



BASKET / CODE: JACBAK

KG 4,0 | unit 1 0,11 mc



Width 55 | Depth 55 | Height 30



PLANTER / CODE: JACPLAN

KG 17,0 | unit 1 0,48 mc



Width 90 | Depth 40 | Height 120

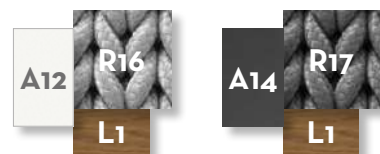



Parasolcollection
// Zeus



Parasolcollection
// Zeus

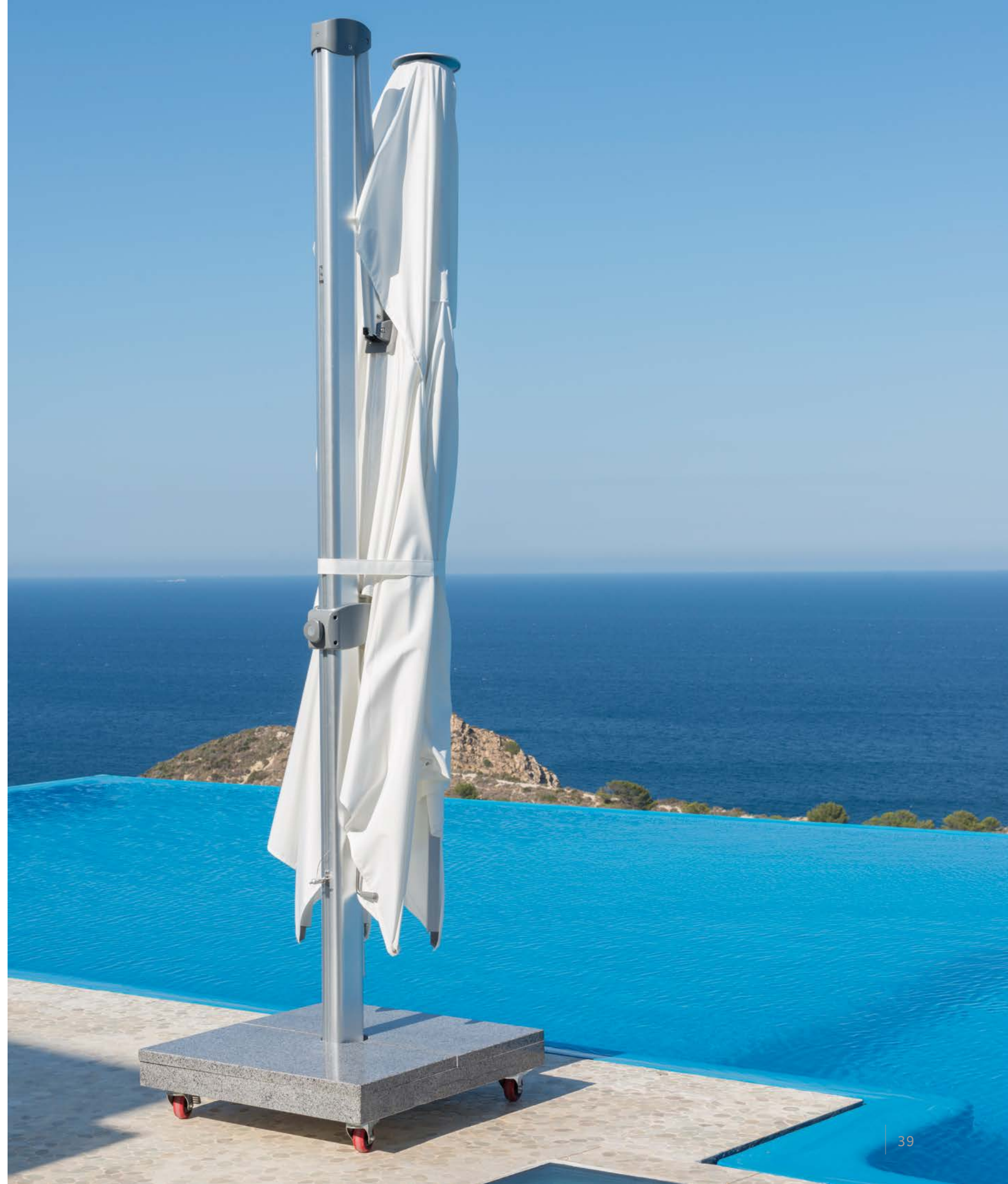

Parasolcollection

// Zeus

ZEUS 3x4 / CODE: PARZES-A

KG 228,0

unit 1+1+1+1
0.53 mc



•80x80•

P1 A10

ZEUS 4x4 / CODE: PARZES2-A

KG 240,0

unit 1+1+1+1
0.53 mc



•80x80•

P1 A10

Finishing

Aluminium frame

Waterproof fabric canopy



anodized

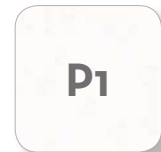

white

Features

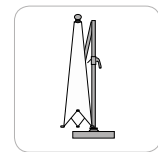

- 1-Telo 3x4 o 4x4 in tessuto da 250g in poliester trattato in PU.
- 2-Optional: illuminazione a batteria ricaricabile.
- 3-Sistema di apertura retrattile che permette la chiusura parallela al palo. Apposite guide di scorrimento ne facilitano lo spostamento.
- 4-Sistema di apertura e chiusura del telo tramite manovella manuale removibile. Il palo girevole permette all'ombrellone di ruotare di 360°.
- Basamento in granito (180kg) con ruote.
- 5-Optional: illuminazione con impianto audio per collegamento dispositivi bluetooth.

- 1-Canopy 3x4 or 4x4 in 250g polyester with PU coating.
- 2-Optional: umbrella lights with rechargeable battery.
- 3-Retractable opening system allows umbrella closure parallel to the pole. Sliding guides make movements easier.
- 4-Canopy opening/closure with removable hand crank. Turning pole allows parasol a 360° rotation. Granite base (180kg) with wheels.
- 5-Optional: umbrella bluetooth speaker with led lights.

Specifiche:
 Palo in alluminio 120x76 mm
 7 Stecche in alluminio 20x35 mm
 Telo UV80+
 Altezza ombrellone 300 cm
 Basamento granito 180 kg 80x80x10 cm
 Resistenza al vento massima 39-49 km/h

Technical specifications:
 Aluminium Pole 120x76 mm
 No.7 alu ribs 20x35 mm
 UV80+ Canopy
 Parasol height 300 cm
 Granite base 180 Kg 80x80x10 cm
 Max. wind resistance 39-49 km/h





Parasolcollection
// Athena







Parasolcollection

// Athena

ATHENA 3x4 / CODE: PARATH



Finishing

Aluminium frame



Waterproof fabric canopy



Features

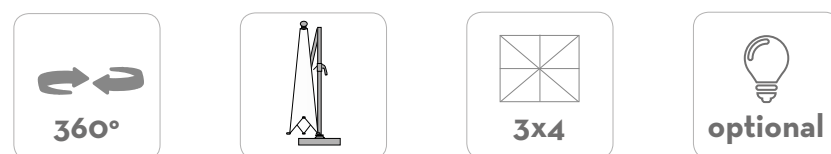

- 1-Telo 3x4 in tessuto da 250g in poliestere trattato in PU.
- 2-Optional: illuminazione a batteria ricaricabile.
- 3-Sistema di apertura retrattile che permette la chiusura parallela al palo. Apposite guide di scorrimento ne facilitano lo spostamento.
- 4-Sistema di apertura e chiusura del telo tramite manovella manuale removibile. Il palo girevole permette all'ombrellone di ruotare di 360°.
- 5-Optional: illuminazione con impianto audio per collegamento dispositivi Bluetooth.
- 6-Basamento in acciaio di colore bianco o tortora. Per una stabilità ottimale si consiglia l'utilizzo di n. 10 piastre in graniglia 50x50x3,5cm (pesi non inclusi).

- 1-Canopy 3x4 in 250g polyester with PU coating.
- 2-Optional: umbrella lights with rechargeable battery.
- 3-Retractable opening system allows umbrella closure parallel to the pole. Sliding guides make movements easier.
- 4-Canopy opening/closure with removable hand crank. Turning pole allows parasol a 360° rotation.
- 5-Optional: umbrella Bluetooth speaker with led lights.
- 6-Steel base in white or dove colour. For a better stability we recommend you to use 10 grit plates 50x50x3,5cm (weights not included).

- Specifiche:
- Palo in alluminio 120x76 mm
 - 7 Stecche in alluminio 20x35 mm
 - Altezza ombrellone 310 cm
 - Telo UV80+
 - Basamento in acciaio 55x133x20 cm (Pesi non inclusi)
 - Resistenza al vento massima 39-49 km/h

- Technical specifications:
- Aluminium Pole 120x76 mm
 - No.7 alu ribs 20x35 mm
 - Parasol height 310 cm
 - UV80+ Canopy
 - Steel base 55x133x20 cm (weights not included)
 - Max. wind resistance 39-49 km/h

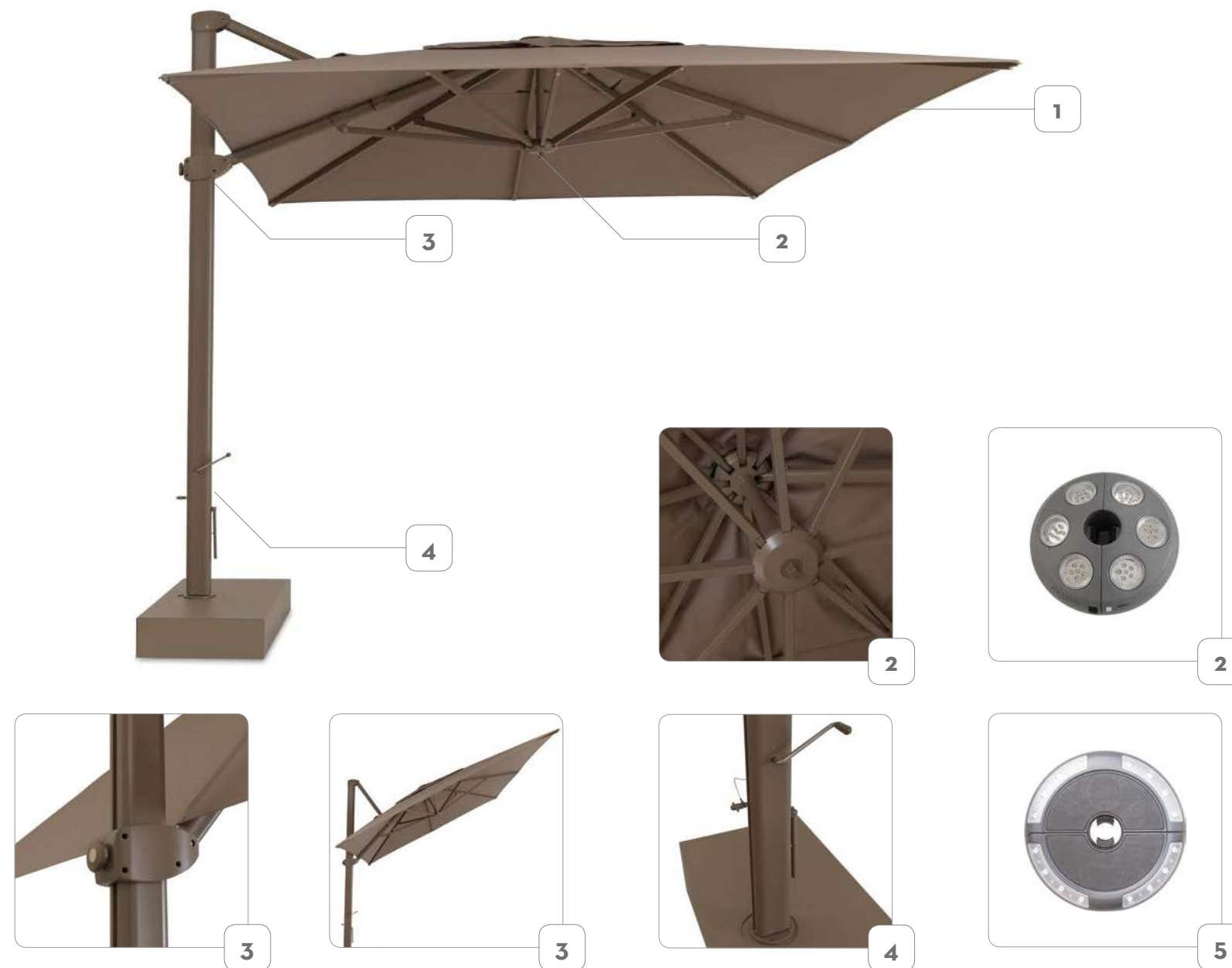



Parasolcollection
// Venere





Parasolcollection

// Venere

VENERE 3x3 / CODE: PARVEN



P1 A10



Finishing

Aluminium frame

Waterproof fabric canopy



anodized

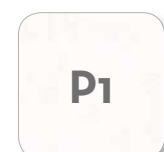

white

Features

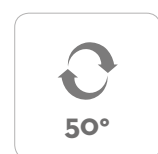

- 1-Telo 3x3 in tessuto da 250g in poliestere trattato in PU.
- 2-Optional: illuminazione a batteria ricaricabile.
- 3-Sistema di apertura retrattile che permette la chiusura parallela al palo. Sistema di apertura e chiusura del telo tramite manovella manuale removibile. Inclinabile fino a 50° su ambedue i lati.
- Il palo girevole permette all'ombrellone di ruotare di 360°.
- 4-Basamento in granito (125 kg) con ruote.
- 5-Optional: illuminazione con impianto audio per collegamento dispositivi Bluetooth.

- 1-Canopy 3x3 in 250g polyester with PU coating.
- 2-Optional: umbrella lights with rechargeable battery.
- 3-Retractable opening system allows umbrella closure parallel to the pole. Canopy opening/closure with removable hand crank. Reclining up to 50° on both sides. Turning pole allows parasol a 360° rotation.
- 4-Granite base (125 kg) with wheels.
- 5-Optional: umbrella Bluetooth speaker with led lights.

Specifiche:
 Palo in alluminio 90x65 mm
 7 Stecche in alluminio 28x14 mm
 Altezza ombrellone 280 cm
 Telo UV80+
 Basamento granito 125 kg 80x80x7 cm
 Resistenza al vento massima 29-38 km/h

Technical specifications:
 Aluminium Pole 90x65 mm
 No.7 aluminium ribs 28x14 mm
 Parasol height 280 cm
 UV80+ Canopy
 Granite base 125 Kg 80x80x8 cm
 Max. wind resistance 29-38 km/h





Parasolcollection
//Marte







Parasolcollection

//Marte

MARTE 3x3 / CODE: PARMAR

KG 116,0 | unit 1+1+1 | 0.28 mc | 8% |

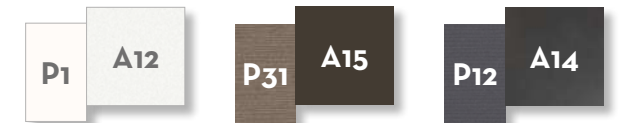

Finishing

Aluminium frame

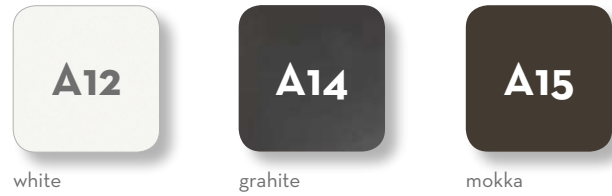

Waterproof fabric canopy



Features

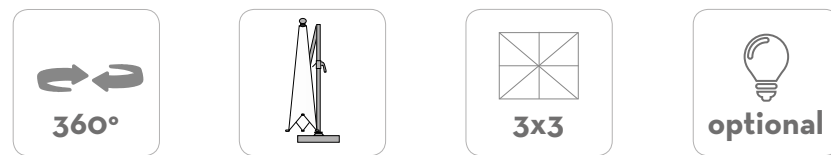

- 1-Telo 3x3 in tessuto da 250g in poliestere trattato in PU.
- 2-Optional: illuminazione a batteria ricaricabile.
- 3-Sistema di apertura retrattile che permette la chiusura parallela al palo. Sistema di apertura e chiusura del telo tramite manovella manuale removibile.
- 4-Basamento in cemento (90 kg) con ruote, di colore bianco o mokka in tinta alla struttura. Il palo girevole permette all'ombrellone di ruotare di 360°.
- 5-Optional: illuminazione con impianto audio per collegamento dispositivi Bluetooth.

- 1-Canopy 3x3 in 250g polyester with PU coating.
- 2-Optional: umbrella lights with rechargeable battery.
- 3-Retractable opening system allows umbrella closure parallel to the pole. Canopy opening/closure with removable hand crank.
- 4-Concrete base (90kg) with wheels, available in white or mokka colour. Turning pole allows parasol a 360° rotation.
- 5-Optional: umbrella Bluetooth speaker with led lights.

- Specifiche:
- Palo in alluminio 80x65 mm
- 7 Stecche in alluminio 28x14 mm
- Altezza ombrellone 290 cm
- Telo UV80+
- Basamento in cemento 90 kg 70x70x8 cm
- Resistenza al vento massima 29-38 km/h

- Technical specifications:
- Aluminium Pole 80x65 mm
- No.7 aluminium ribs 28x14 mm
- Parasol height 290 cm
- UV80+ Canopy
- Concrete base 90 Kg70x70x8 cm
- Max. wind resistance 29-38 km/h





Parasolcollection
// Vulcano



Parasolcollection

// Vulcano

VULCANO 3x3 / CODE: PARVUL

KG 24,0 | unit 1 0.17 mc | ☀️ | 🔑

P1 A12



Finishing

Aluminium frame

Waterproof fabric canopy

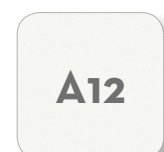

white

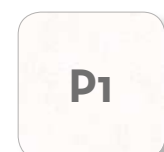

white

Features

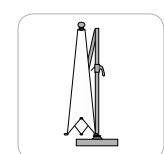
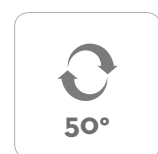

- 1-Telo 3x3 in tessuto da 250g in poliestere trattato in PU.
- 2-Optional: illuminazione a batteria ricaricabile.
- 3-Sistema di apertura retrattile che permette la chiusura parallela al palo. Sistema di apertura e chiusura del telo tramite manovella manuale removibile. Inclinabile fino a 50° su ambedue i lati.
- 4-Basamento con crociera in acciaio colore bianco. Per una stabilità ottimale si consiglia l'utilizzo di n.4 piastre in graniglia 50x50x4cm (pesi non inclusi).
- Il palo girevole permette all'ombrellone di ruotare di 360°.
- 5-Optional: illuminazione con impianto audio per collegamento dispositivi Bluetooth.

- 1-Canopy 3x3 in 250g polyester with PU coating.
- 2-Optional: umbrella lights with rechargeable battery.
- 3-Retractable opening system allows umbrella closure parallel to the pole. Canopy opening/closure with removable hand crank. Reclining up to 50° on both sides.
- 4-Steel white cross base with 4 grit plates. For a better stability we recommend you to use 4 grit plates 50x50x4cm (weights not included). Turning pole allows parasol a 360° rotation.
- 5-Optional: umbrella Bluetooth speaker with led lights.

- Specifiche:
- Palo in alluminio 80x60 mm
- 8 Stecche in alluminio 20x14 mm
- Altezza ombrellone 280 cm
- Telo UV80+
- Basamento con 4 piastre in graniglia 50x50x4 cm (pesi non inclusi)
- Restistenza al vento massima 29-38 km/h

- Technical specifications:
- Aluminium Pole 80x60 mm
- No.8 aluminium ribs 20x14 mm
- Parasol height 280 cm
- UV80+ Canopy
- Base with 4 grit plates in size 50x50x4 cm(Weights not included)
- Max. wind resistance 29-38 km/h





Parasolcollection
// Apollo



Parasolcollection

// Apollo

APOLLO 2x2 / CODE: PARAPO

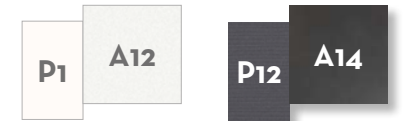

Finishing

Aluminium frame



white



graphite

Waterproof fabric canopy



white



dark grey

Features

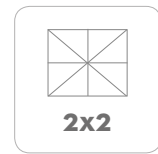
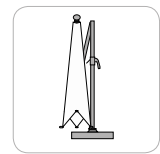

2x2

- 1 - Telo 2x2 in tessuto da 220g in poliestere trattato in PU.
- 2 - Sistema di apertura semplice ed intuitivo, spingere il tetto dell'ombrellone verso l'alto finché il meccanismo non si arresta.
- 3 - Puntale in alluminio cromato.
- 4 - Basamento in acciaio colore bianco da 40 kg.

- 1 - Canopy 2x2 in 250g polyester with PU coating.
- 2 - Easily parasol opening: push upwards the parasol roof until it locks.
- 3 - Chrome-plated alu tip.
- 4 - Steel white base 40 Kg.

Specifiche:
 Palo in alluminio ø 38 mm
 4 Stecche in alluminio ø 20 mm
 Altezza ombrellone 245 cm
 Telo UV80+
 Basamento in acciaio 40 kg 50x50x2 cm
 Resistenza al vento massima 30 km/h

Technical specifications:
 Aluminium pole diam. 38 mm
 Parasol height 250 cm
 No. 4 aluminium ribs diam. 20 mm
 UV80+ Canopy
 Steel base 40 Kg 50x50x2 cm
 Max. wind resistance 30 km/h

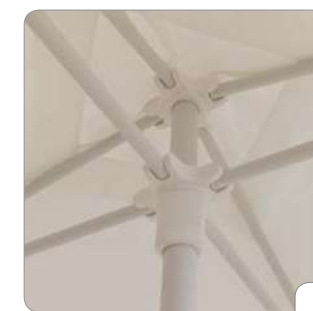



Accessoriescollection
// Fabric Carpet





// Ribs





// Quadro



// Quadro

Accessories collection

// Fabric Carpet

Finishing

Fabric quadro



canvas



light grey



dark grey



red



dark green

Fabric ribs



canvas



light grey



dark grey



dark green

QUADRO 400x300 / CODE: TAPQ3

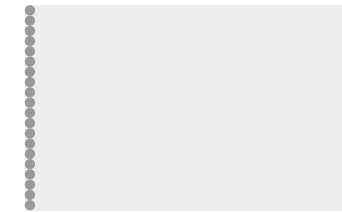

Width 400 | Depth 300

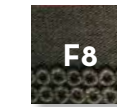
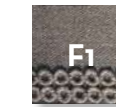

KG 48,0 | unit 1 0.32 mc |

QUADRO 300x200 / CODE: TAPQ1

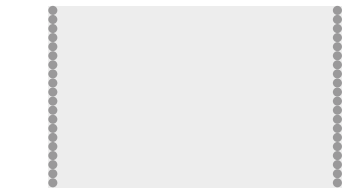

Width 300 | Depth 200

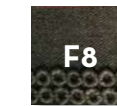
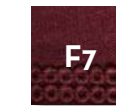
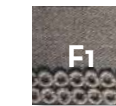

KG 30,0 | unit 1 0.27 mc |

QUADRO 240x160 / CODE: TAPQ2

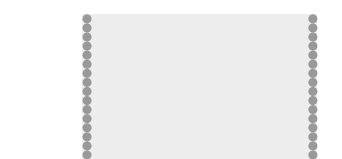

Width 240 | Depth 160

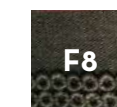
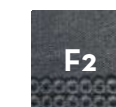

KG 15,0 | unit 1 0.18 mc |

RIBS 400x300 / CODE: TAPR3

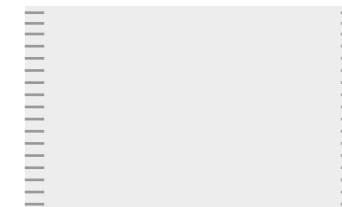

Width 400 | Depth 300

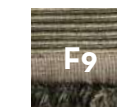
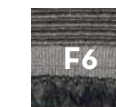
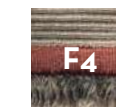

KG 48,0 | unit 1 0.32 mc |

RIBS 300x200 / CODE: TAPR1

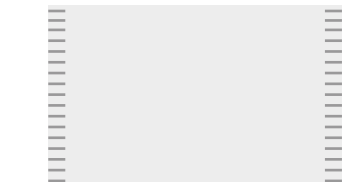

Width 300 | Depth 200

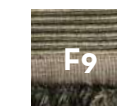
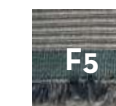
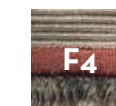

KG 30,0 | unit 1 0.27 mc |

RIBS 240x160 / CODE: TAPR2



Width 240 | Depth 160

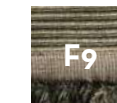
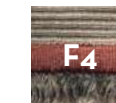

KG 15,0 | unit 1 0.18 mc |



Casildacollection
// Lamp
Design Ramon Esteve



Casilda collection

Design Ramón Esteve

Finishing

Stainless steel frame



Accoya wood table top

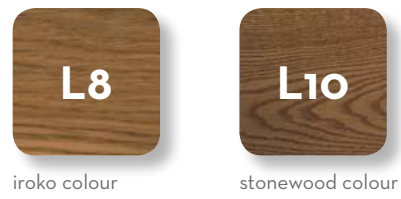

LAMP L / CODE: CASILAMPL



Width 23 | Depth 20 | Height 175

KG 10,0 | unit 1 0.12 mc | LED 28W 2800K

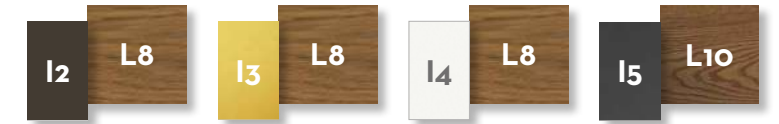

LAMP S / CODE: CASILAMPS



Width 63 | Depth 15 | Height 40

KG 5,0 | unit 1 0.02 mc | LED 6W 2800K

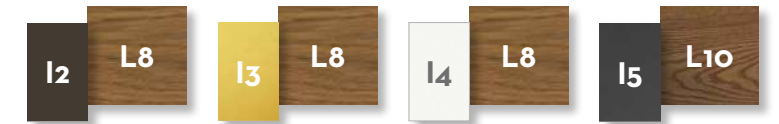

LAMP XS / CODE: CASILAMPXS



Width 23 | Depth 20 | Height 40

KG 2,5 | unit 1 0.02 mc | LED 2W 2800K

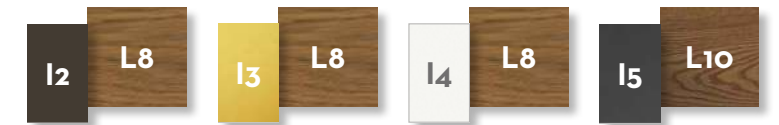



Tribalcollection

// Lamp

Design Ludovica + Roberto Palomba

Tribalcollection

small, medium & big lamp
dove frame
sand colour rope





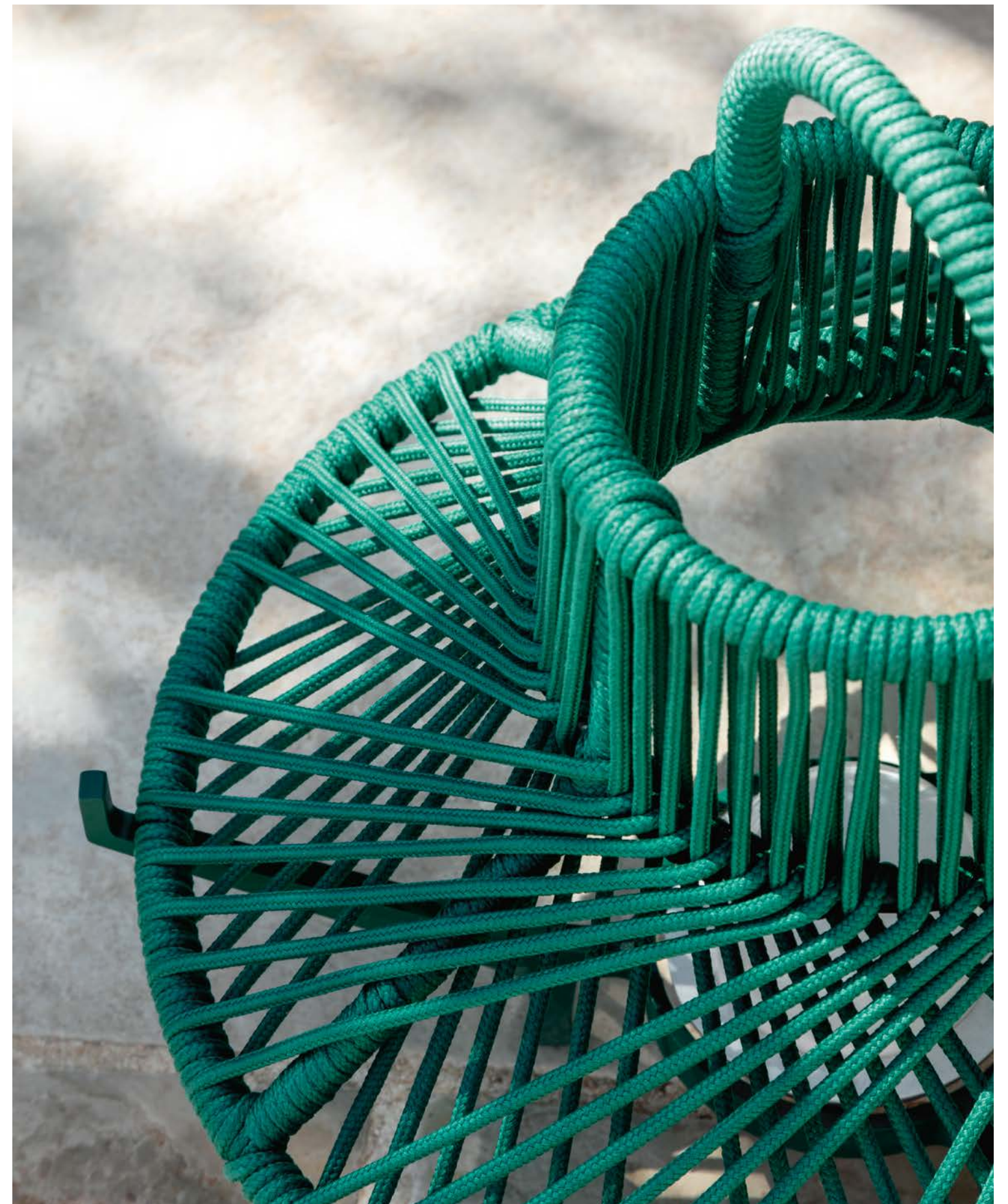

Tribal collection

// Lamp

Finishing

Aluminium frame



yellow



teal green

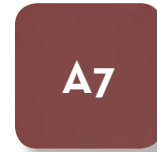

red



dove

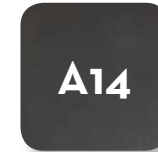

graphite

Synthetic rope



dark grey



yellow



red



sand



teal green

TRIBAL BIG / CODE: TRIB01



Width 60 | Depth 60 | Height 175

KG 11,0 | unit 1 0.76 mc | LED 7W 2800K



TRIBAL MEDIUM / CODE: TRIB02



Width 45 | Depth 45 | Height 85

KG 4,0 | unit 1 0.23 mc | LED 7W 2800K



TRIBAL SMALL / CODE: TRIB03



Width 45 | Depth 45 | Height 45

KG 2,5 | unit 1 0.13 mc | LED 3.5W 2800K



TRIBAL CELIN / CODE: TRIB04



Width 45 | Depth 45 | Height 71

KG 3,0 | unit 1 0.19 mc | LED 7W 2800K





Cleocollection
//Lamp
Design Marco Acerbis











Cleo collection

// Lamp

Finishing

Aluminium frame



white

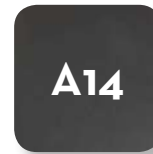

graphite

Stainless steel frame



white



graphite



dove

Covering fabric



dark grey



light grey

LANTERN H66 / CODE: CLEL01



Width 35 | Depth 35 | Height 66

KG 9,0 | unit 1 0.11 mc | LED 3.5W 2800K

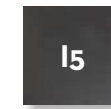

LANTERN H90 / CODE: CLEL02



Width 40 | Depth 40 | Height 90

KG 10,0 | unit 1 0.17 mc | LED 7W 2800K

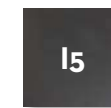

LANTERN H120 / CODE: CLEL03



Width 45 | Depth 45 | Height 120

KG 12,0 | unit 1 0.28 mc | LED 7W 2800K

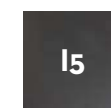

FLOOR LAMP / CODE: CLEALUL01



Width 70 | Depth 70 | Height 190

KG 11,0 | unit 1 1.04 mc | LED 7W 2800K



ARC LAMP / CODE: CLEALUL02



Width 201 | Depth 45 | Height 225

KG 18,0 | unit 1 0.18 mc | LED 12W 2800K

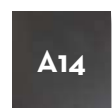
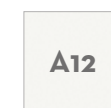



Milocollection
// Lamp
Design Marco Acerbis







Milocollection

// Lamp

Finishing

Stainless steel frame



white

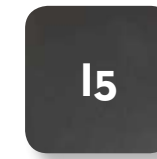

graphite

FLOOR LAMP 01 / CODE: MLOL01

KG 7,0 | unit 1 0,14 mc | 12W max led E27

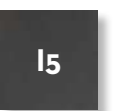

Width 37 | Depth 37 | Height 60

FLOOR LAMP 02 / CODE: MLOL02

KG 13,0 | unit 1 0,18 mc | 12W max led E27

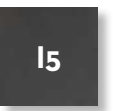

Width 33 | Depth 33 | Height 100

FLOOR LAMP 03 / CODE: MLOL03

KG 25,0 | unit 1 0,39 mc | 12W max led E27

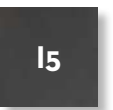

Width 45 | Depth 45 | Height 150



Toffeecollection
// Lamp





Toffee collection

// Lamp

Finishing

Aluminium frame



white

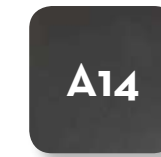

graphite

TOFEE / CODE: TOF01

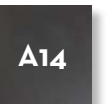
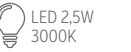

Width	Depth	Height
11	11	19



Scaccocollection
// Paravento
Design Ludovica + Roberto Palomba



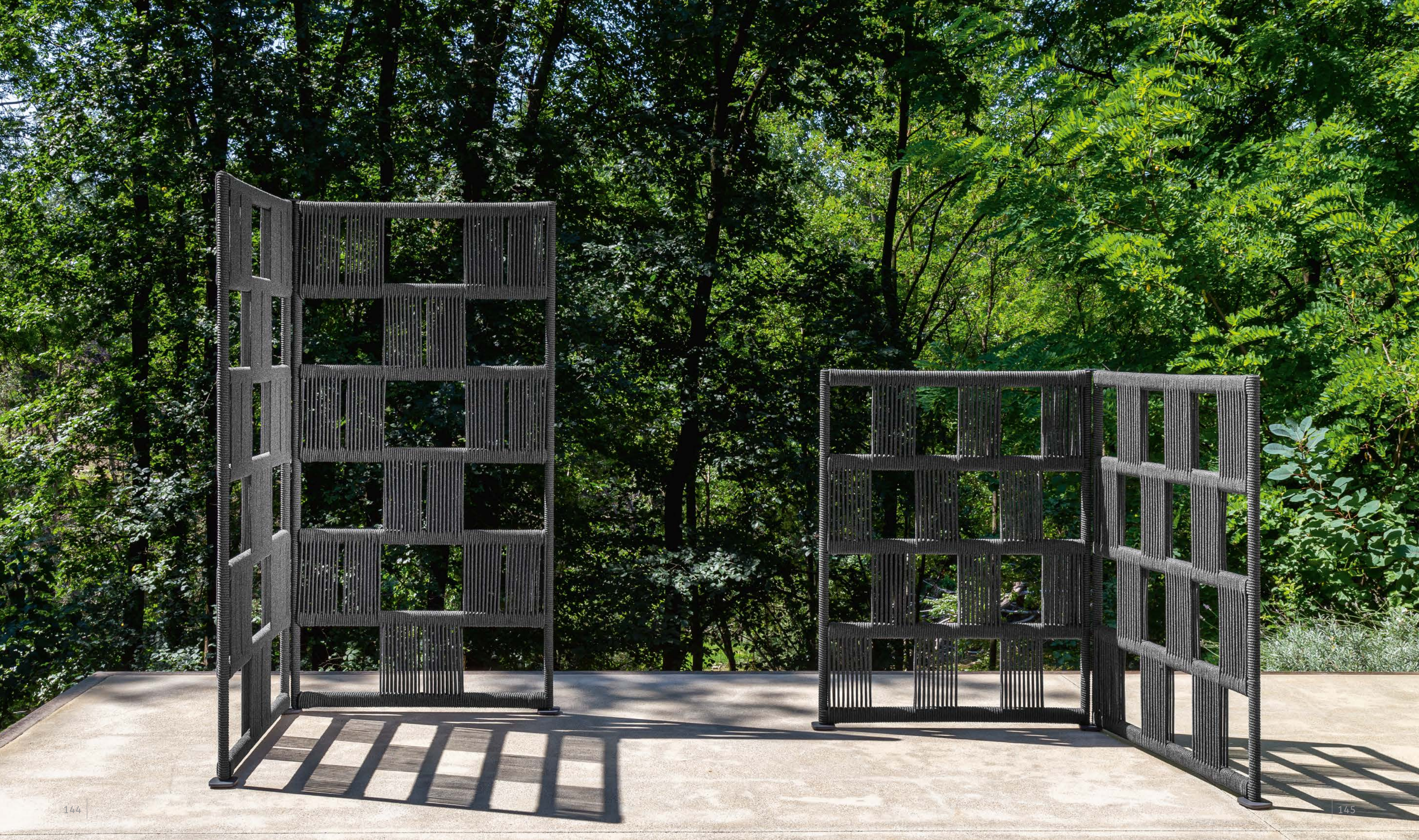



Scacco collection

// Paravento

Finishing

Aluminium frame

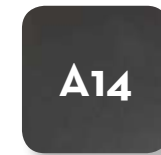

graphite



beige

Syntetic rope



beige



dark grey

PARTITION H135 / CODE: SCAPAR135



Width 100 | Depth 5 | Height 135



PARTITION H200 / CODE: SCAPAR200



Width 100 | Depth 2 | Height 200





Tikalcollection
// Scaffali
Design Nicola de Pellegrini



Finishing

Metal frame



magnesit

SHELF MODULE 120X190 / CODE: TIKSCA120



MT1

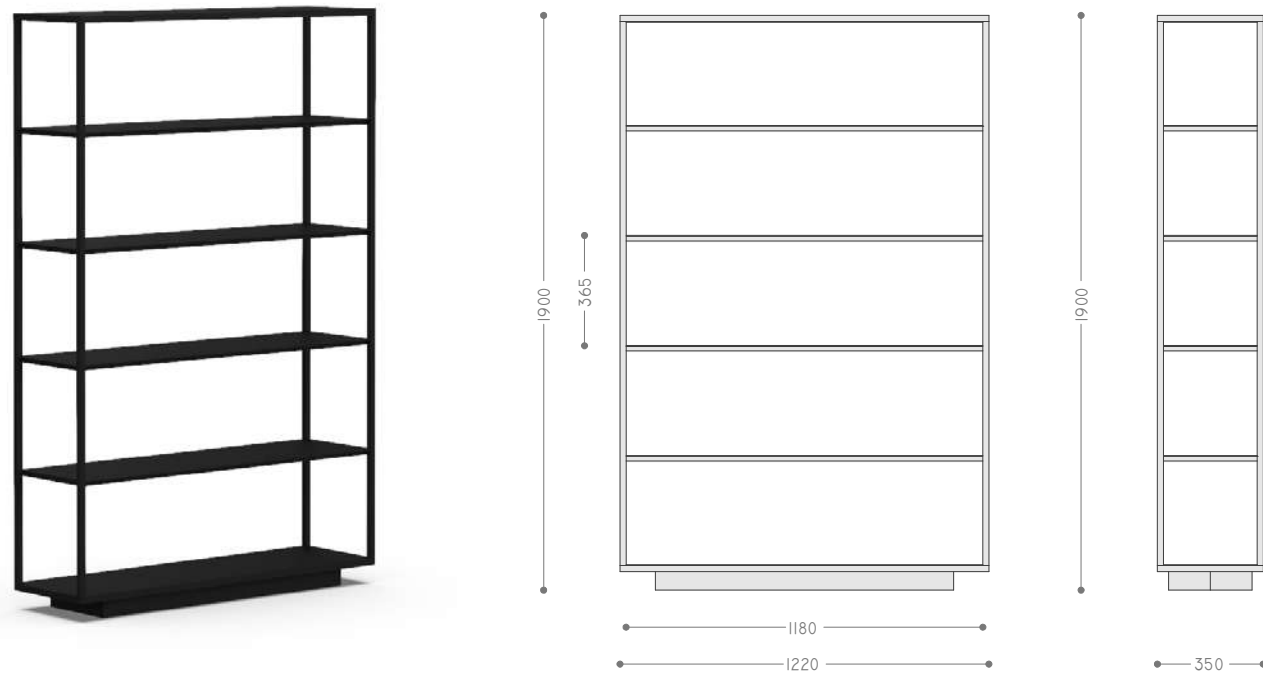

SHELF MODULE 80X190 / CODE: TIKSCA80



MT1

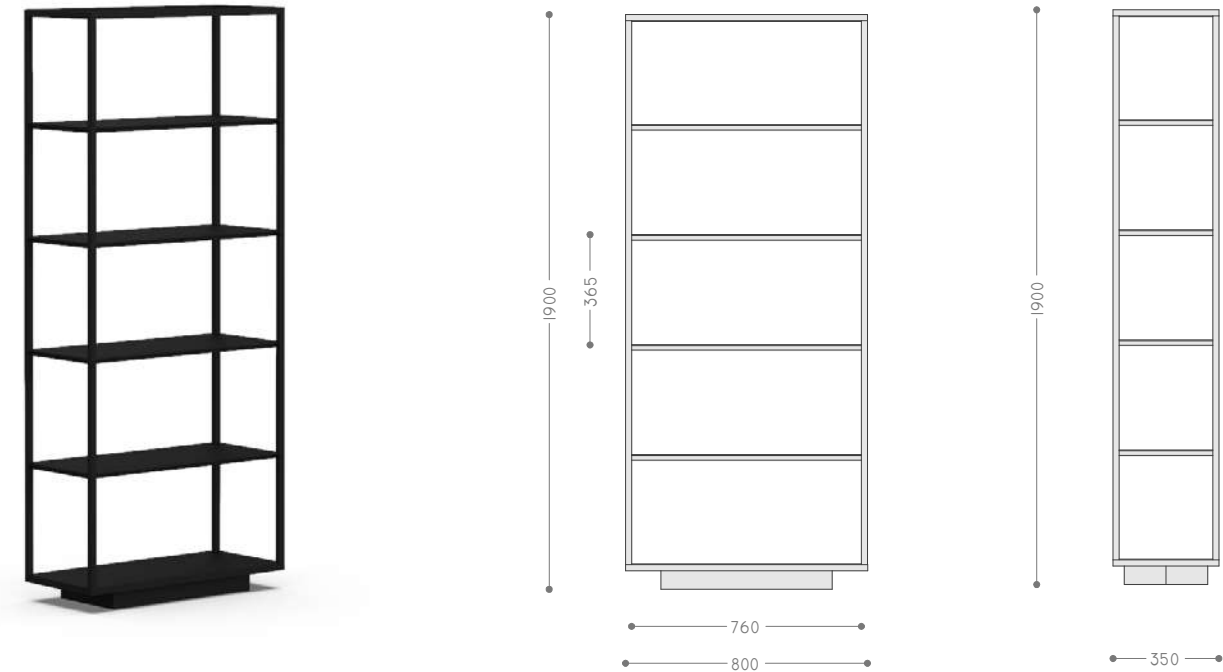

SUSPENDED CABINET WITH FLAP DOOR 118X36 / CODE: TIKSCA120M



MT1

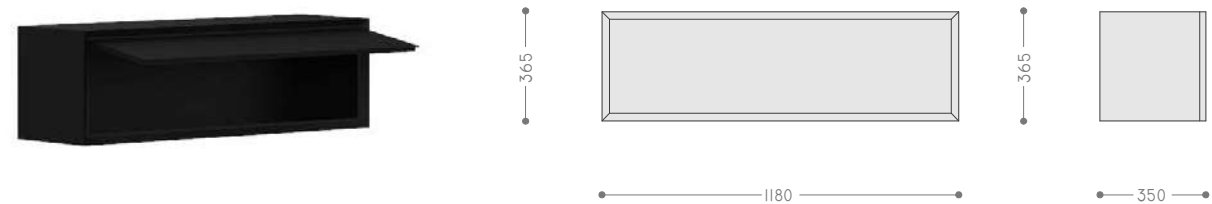

CABINET BASE / CODE: TIKSCA80M



MT1

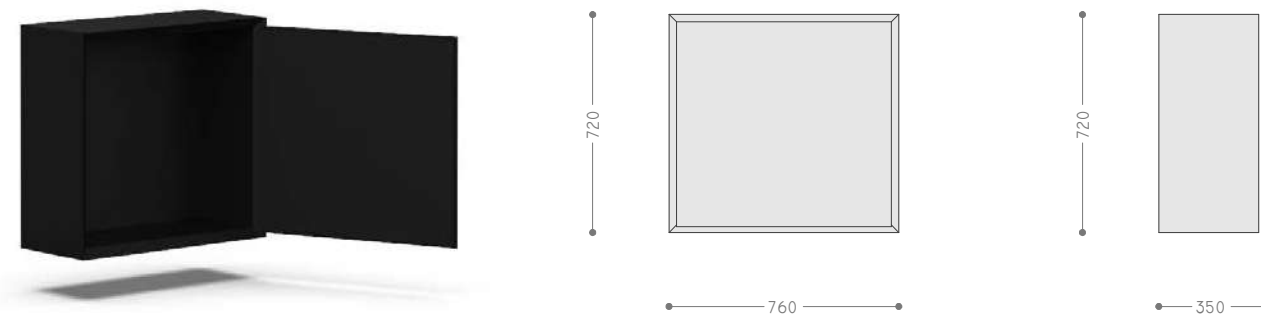



Accessoriescollection
// Wave



Accessories collection

// Wave

Finishing

Aluminium frame



white

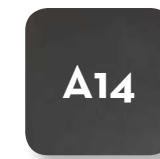

graphite

WAVE SHOWER / CODE: DCCWAV



Width	Depth	Height
82	82	236

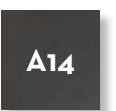



Accessoriescollection
// Cart







Accessories collection

// Cart

Finishing

Aluminium frame



white



dove

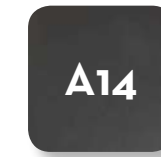

graphite

Wood slats



teak

CART / CODE: ACCCAR

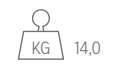

Width 90 | Depth 55 | Height 76





Accessoriescollection
// Ray





Accessories collection

// Ray

Aluminium frame



charcoal



graphite



dove

SMALL SERVING TABLE / CODE: RAYVP



Width 60 | Depth 60 | Height 45

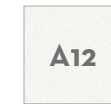

BIG SERVING TABLE / CODE: RAYVG



Width 60 | Depth 60 | Height 73

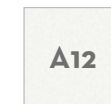



Accessoriescollection
// Box





Accessories collection

// Box

Finishing

Aluminium frame



white



dove

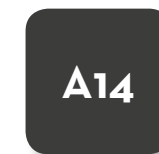

graphite

Textilene covering



white



dove



silver black

BOX / CODE: BOXAL01



Width 130 | Depth 60 | Height 58





Accessoriescollection
// Planter
Design Roberto Serio







Accessories collection

// Planter

Finishing

Steel frame



white

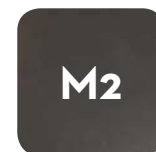

graphite

PLANTER / CODE: ACCFIO



Width 88 | Depth 27 | Height 60

KG 16,0 | unit 1 0.19 mc |

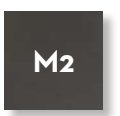

BIOETHANOL FIREPLACE / CODE: ACCCAM



Width 88 | Depth 27 | Height 66

KG 20,0 | unit 1 0.20 mc |

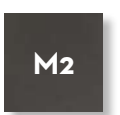

STONE PLANTER / CODE: ACCFIOSTO



Width 88 | Depth 27 | Height 90

KG 22,0 | unit 1 0.21 mc |

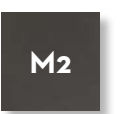

PLANTER OLIVE DECORATE / CODE: ACCDEC1



Width 88 | Depth 27 | Height 170

KG 30,0 | unit 1+1 0.48 mc |

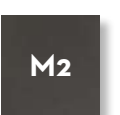

PLANTER AGAVE DECORATE / CODE: ACCDEC2



Width 88 | Depth 27 | Height 170

KG 30,0 | unit 1+1 0.48 mc |

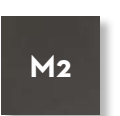



Accessoriescollection
// Upperalu





Accessories collection

// Upperalu

Finishing

Aluminium frame



white



dove



graphite

Textilene canopy

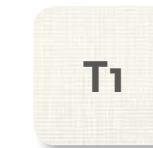

white

SHADING 3X4 H235 / CODE: UPPA01

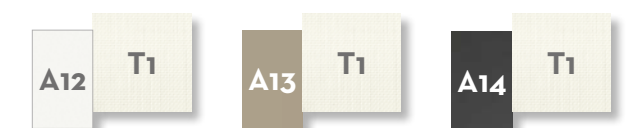
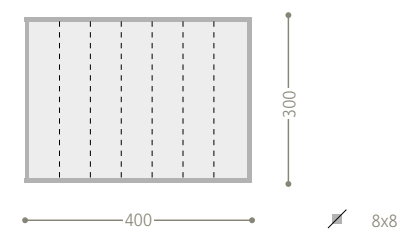

SHADING 3X3 H235 / CODE: UPPA02

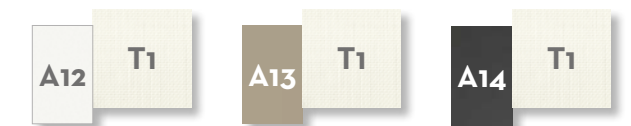
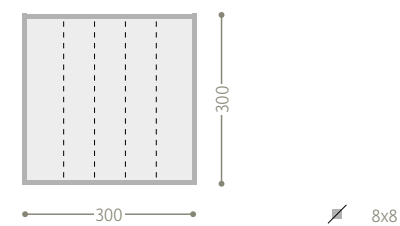

Materials

Alluminio / Aluminium



Teal green



Charcoal



Silver



Bianco
White



Tortora
Dove colour

Alluminio / Aluminium



Grafite
Graphite



Mokka



Beige

Acciaio / Steel



Bianco
White



Grafite
Graphite

Alluminio: Grazie alla fusione di più leghe di alluminio che ne garantiscono solidità, maneggevolezza ed inattaccabilità alla ruggine, è un materiale di elevata qualità e permette di raggiungere i massimi risultati qualitativi ed estetici.

Inox: L'acciaio inossidabile è un materiale che, grazie alla sua alta resistenza alla corrosione e alle caratteristiche meccaniche di rilievo, risulta maggiormente duraturo e affidabile nel tempo.

Acciaio: Lega di ferro e carbonio con percentuale di carbonio inferiore al 2% trattata per resistere agli agenti atmosferici con il processo della cataforesi e verniciatura a polvere.

Manutenzione: Per mantenere a lungo il prodotto in buone condizioni, consigliamo una corretta pulizia periodica, particolarmente frequente in località caratterizzate da forte umidità e clima marino. Si raccomanda di pulire le superfici con un panno morbido utilizzando acqua o detersivi neutri. Prolungate ed ininterrotte esposizioni a intense radiazioni UV o a temperature molto rigide possono incidere sulle caratteristiche iniziali del rivestimento estetico colorato costituito da poliestere. Consigliamo di pulire e conservare in luoghi riparati i prodotti durante periodi d'inutilizzo prolungato e invernali.

Aluminum: Thanks to the fusion of several aluminum alloys that guarantee solidity, manageability and rust resistance, it is a material of high quality and allows to reach the maximum qualitative and aesthetic results.

Inox: Stainless steel is a material that, thanks to its high resistance to corrosion and to the mechanical characteristics of relief, is more durable and reliable over time.

Steel: Iron and carbon alloy with carbon percentage less than 2% treated to resist to the atmospheric agents with the cathoresis process and powder coating.

Maintenance: To keep the product in good condition for a long time, we recommend a regular cleaning period, particularly frequent in places characterized by high humidity and marine climate. We recommend cleaning the surfaces with a soft cloth using water or neutral detergents. Prolonged and uninterrupted exposures to intense UV radiation or at very low temperatures can affect the initial characteristics of the colored polyester coating. We recommend cleaning and storing products in sheltered areas during long periods of non-use and winter.

Materials

Corde sintetiche / Synthetic ropes



Grigio scuro
Dark grey



Tortora
Dove



Grigio chiaro
Light grey



Grigio scuro
Dark grey

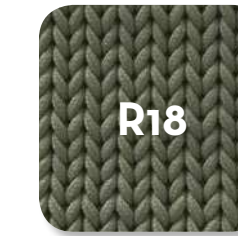

Verde militare
Hunter green



Giallo
Yellow



Rosso
Red



Sabbia
Sand

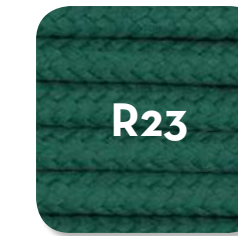

Verde petrolio
Teal green

Doppia treccia costruita con anima in poliestere e copertura in propilene multi filamento. La fibra esterna di cui è composta è impermeabile e resistente ai raggi UV.

Si raccomanda di pulire con prodotto neutro e panno non abrasivo.

Double braid made with polyester core and multi-filament propylene cover. The external fiber is waterproof and resistant to UV rays.

It is recommended to clean with a neutral product and a non-abrasive cloth.

Materials

Legni / Wood



Teak

Teak: Materiale di elevata qualità ideale per la realizzazione di mobili da esterno perché estremamente resistente ai cambiamenti di temperatura, all'acqua, all'umidità e alla salsedine.

Trattandosi di un materiale naturale si potrebbero osservare variazioni di colore o anche crepe dovute al grado di umidità ed ai bruschi cambiamenti di temperatura. Qualora non ricevesse alcun trattamento di manutenzione, mediante l'applicazione periodica di comuni e specifici protettivi a base olio, la superficie potrebbe prendere una patina grigio argento che potrà essere eliminata con una leggera carteggiatura superficiale e successiva lucidatura con panno di iuta. Piccole macchie superficiali dovute ad olio o altri prodotti alimentari dovranno essere rimosse tempestivamente, prima che il legno possa assorbirle in profondità, carteggiando la superficie interessata e lucidandola successivamente con un panno di iuta.

Teak: High quality material suitable for outdoor furniture because it is extremely resistant to changes in temperature, water, humidity and saltiness.

Being a natural material, colour variations or even cracks due to the degree of humidity and sudden changes in temperature may be observed. If no maintenance treatment is received, through the periodic application of common and specific protective oil-based, the surface may take a silver-gray patina that can be easily removed with a light surface sanding down and subsequent polishing with a jute cloth. Small superficial stains due to oil or other food products must be removed promptly, before the wood can absorb them in depth, sanding down the affected surface and then polishing it with a jute cloth.

Materials

Tappeti / Carpet



Canvas



Grigio chiaro
Light grey



Grigio scuro
Dark grey



Rosso
Red



Verde scuro
Dark green



Canvas

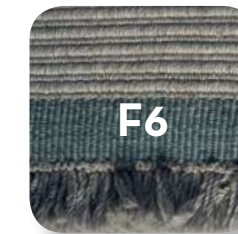

Grigio chiaro
Light grey



Grigio scuro
Dark grey



Verde scuro
Dark green

I tappeti sono realizzati in filato di fibra sintetica, hanno un trattamento idrorepellente, antimacchia e antimuffa.

Il filato in PP ha una resa ottimale in ambienti esterni, per durata e resistenza agli agenti atmosferici ed ha un'elevata stabilità ai raggi UV.

Manutenzione quotidiana: aspirapolvere senza spazzole.

Manutenzione periodica: lavaggio a secco o pulizia a vapore.

Macchie: tamponare con un panno pulito; agire con detersivi specifici seguendo attentamente le istruzioni del produttore.

All the carpets are made of synthetic fabric and through a special treatment they are waterproof, stain-resistant and anti-bacterial. The PP yarn ensures an excellent performance in terms of long-lasting durability, weather and UV rays resistance.

Daily cleaning: vacuum cleaner without brushes.

Deeper cleaning: professional dry cleaning or steam cleaning.

Stains: pat the area with a clean cloth; use specific detergents following the manufacturer's instructions.

Materials

Tessuto 100% pl, idrorepellente / 100% pl fabric, water repellent



Bianco
White



Grigio scuro
Dark grey



Tortora
Dove

Il poliestere è un materiale adatto all'arredo esterno perchè semplice da pulire, trattare e lavare.

Ha elevate caratteristiche meccaniche: resiste alla rottura, alla luce, all'abrasione, non si deforma in modo permanente ed ha un ottimo recupero elastico.

È idrorepellente, quindi perfetto se installato vicino ad un bordo piscina o se esposto a situazioni climatiche avverse.

Prima di chiudere l'ombrellone è importante assicurarsi che il telo sia perfettamente asciutto.

Durante i mesi di non utilizzo l'ombrellone deve essere riposto in un ambiente asciutto e protetto dalla relativa cover. Evitare il contatto prolungato con sostanze grasse e/o coloranti che potrebbero venire assorbite dal materiale di rivestimento e dare luogo a macchie permanenti, oltre che deteriorare la struttura del filato. Non usare solventi. Utilizzare acqua e detersivi liquidi non abrasivi con PH neutro e incolore. Eventualmente lasciare agire il detersivo alcuni minuti. Sciacquare abbondantemente con acqua a temperatura non superiore a 30°C.

Polyester is a material suitable for outdoor furniture because it is easy to clean, treat and wash.

It has high flexural strength characteristics: it resists breakage, light, abrasion, does not deform permanently and has an excellent elastic shape recovery.

It is water repellent, therefore perfect if installed near swimming pool areas or if exposed to adverse weather conditions.

Before closing the parasol it is important to make sure that the cloth is perfectly dry.

During the months of not using the umbrella must be stored in a dry place and protected by the appropriate cover. Avoid prolonged contact with greasy substances which could be absorbed by the coating material and give rise to permanent stains, as well as deteriorating the yarn structure. Do not use solvents. Use water and non-abrasive liquid detergents with neutral PH and colourless. If necessary, allow the detergent to act for a few minutes. Rinse with water at a temperature not exceeding 30 ° C.

Materials

Textilene



Bianco
White



Tortora
Dove

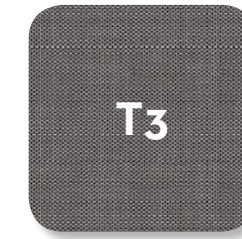

Silver black

Il Textilene è una fibra di poliestere protetta da un rivestimento in PVC. Le fibre vengono poi legate insieme in modo da ottenere una sostanza fibrosa particolarmente solida e permanente, resistente allo stiramento ed immune da strappi.

La caratteristica più importante è la sua elasticità, offre un'eccellente resistenza alle muffe e alle macchie, e presenta un trattamento superficiale contro la degradazione UV.

Il textilene può essere pulito semplicemente con un panno di spugna con acqua saponata. Abrasivi e solventi devono essere assolutamente evitati!

Si asciuga molto rapidamente a causa della loro struttura aperta.

Textilene is a polyester fiber protected by a PVC coating. The fibers are bonded together so in order to obtain a particularly solid fibrous material which is durable, resistant to stretching and wear resistant too.

The most important characteristic is its elasticity, offers excellent resistance to inhibits mold and stains, and has a surface treatment against UV degradation.

Textilene can simply be cleaned with a sponge cloth with soapy water. Abrasives and solvents must absolutely be avoided!

It dries very quickly due to their open structure.

Technical information

Legenda / Legend

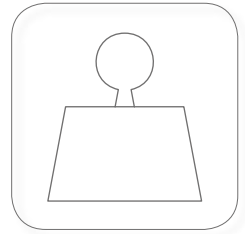

Peso netto KG
Net weight KG



Unità per imballo
Unit for box

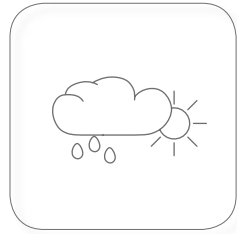

Resistente alle intemperie
Weather-resistant

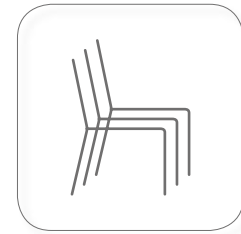

Impilabile
Stackable

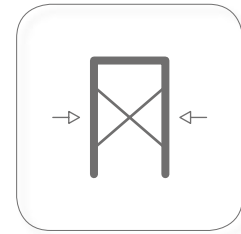

Pieghevole
Folding

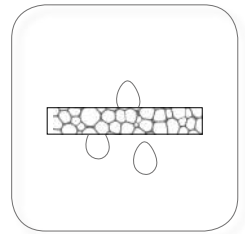

Imbottitura in dry foam
Quick dry foam padding

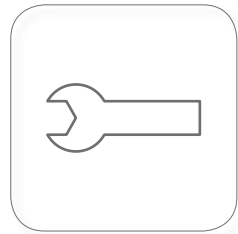

Articolo da assemblare
To assemble



Provisto di illuminazione
With lighting system

Per ogni articolo sono indicate caratteristiche, dimensioni, peso, numero dei pezzi nell'imballo, materiali e colori.

For each item are provided features, sizes, weight, packaging, material, available colours.

CONDIZIONI GENERALI DI VENDITA

1. I colori, disegni e misure dei prodotti presenti nel catalogo sono indicativi. La Talenti srl ha facoltà di eliminare o modificare i modelli delle proprie collezioni senza alcun preavviso.
2. I prezzi dei modelli standard sono espressi nello specifico listino prezzi fornito dall'azienda. Per quanto riguarda gli articoli su misura il preventivo verrà tempestivamente fornito dalla Talenti dietro richiesta del cliente.
3. L'acquirente è tenuto a controllare sempre la merce e ad indicare nel DDT la data di ricevimento, la persona che la riceve ed il timbro della ditta, nonché le eventuali anomalie nel materiale. Talenti srl accetterà esclusivamente reclami presentati entro 5 (cinque) giorni dal ricevimento della merce.
4. La Talenti srl con la consegna al vettore in nessun caso risponde dei rischi a cui la merce è sottoposta durante il trasporto. Quindi eventuali ammanchi, rotture, deterioramenti o manomissioni sono a totale carico dell'acquirente.
5. Gli ordini dovranno essere fatti per scritto utilizzando i codici, descrizioni e prezzo come da catalogo e listini prezzi relativi.
6. Per ogni controversia è competente il foro di Terni (Italia).

GENERAL CONDITIONS OF SALE

1. *The colours, drawings and sizes of the products in this catalogue are approximate. Talenti srl reserves the right to discontinue or change the models in its collections at any time without advance notice.*
2. *The prices of the standard models are expressed in the specific price list that Talenti srl will provide. Concerning customized items the offer will be immediately made and provided by Talenti srl on request of the customer.*
3. *The purchaser is always required to inspect the goods and indicate on the transport document the date of receipt, the person who received it and the company's stamp, as well as any anomalies found in the material. Talenti srl will not accept any claims presented more than 5 (five) days after receipt of the goods.*
4. *Once Talenti srl has delivered products to the carrier, it is no longer responsible for risks these are subject to during transport. The purchaser is thus totally responsible for any missing pieces, breakage, deterioration or tampering.*
5. *Orders must be in writing using the codes, descriptions and prices shown in the catalogue and price lists.*
6. *The Court of Terni (Italy) will be exclusively competent for any disagreements.*

INFORMATIVA AI SENSI ART.13 D. Lgs. n. 196/03

“Codice in materia di protezione dei dati personali”
Il trattamento dei dati personali si svolge nel rispetto dei diritti e delle libertà fondamentali, con particolare riferimento alla riservatezza e al diritto alla protezione.
Il trattamento viene effettuato per adempiere ad obblighi amministrativo-contabili e fiscali e per l'esecuzione degli obblighi contrattuali.
I Vs. dati possono essere comunicati, oltre che a tutti gli incaricati del trattamento all'interno dell'azienda, a consulenti amministrativi, contabili e legali, ad Istituti Bancari.

Titolare del trattamento è TALENTI SRL avente sede legale in Strada Amerina km 4,5, 05022 - Amelia (Tr) - Italy
 Al Titolare del trattamento ci si potrà rivolgere per far valere i diritti previsti dall'art. 7 del D.Lgs 196/03.

NOTICE UNDER DL 196/2003, THE PRIVACY LAW

Your personal information will be handled with respect for your rights and fundamental liberties and with particular reference to confidentiality and the right of protection. Your information will be handled to fulfil our administrative, accounting and tax obligations and to fulfil our contractual obligations. In addition to the company's employees assigned to handle your information internally, it may also be communicated to administrative, accounting and legal consultants and to banks.

The owner of the information for handling purposes is Talenti Srl, which is located at Strada Amerina km 4,5, 05022 - Amelia (Tr) - Italy. You may contact the owner to assert your rights under article 7 of DL 196/2003.

© 2020/2021 - Talenti S.r.l. - Prima edizione
Tutti i diritti riservati - All rights reserved

GRAPHIC DESIGN CONCEPT:
Studio Palomba Serafini Associati
Talenti Technical Department

GRAPHIC DESIGN EDITING:
Talenti Technical Department

PHOTOS:
Giordano Mocchegiani
Giordano Mocchegiani per Rplus
Roberto Sacchini
Gruppo Bento

DECOR:
Francesca Conti
Silvia Garattoni
Talenti Technical Department

POST PRODUCTION:
Area 453

SELECTION:
Studio 59

COPYWRITING:
Talenti S.r.l.

PRINT:
Sinchromia srl

THANKS TO:
Salvadori
Rina Menardi
Kristina Dam Studio
101 Copenhagen
Valerie Objects

Talenti S.r.l.
Strada Amerina km 4,5
05022 - Amelia (Tr) - Italy
customerservice@talentisrl.com
www.talentisrl.com